



RIO Series

LINEAR DRAIN/STRAINER

MODEL: WAVE

Description

ABS linear drain/strainer (Acrylonitrile Butadiene Styrene) with matte finish AISI 304 stainless steel grate and a thickness of 0.8 mm / 0.03" designed to replace the traditional grate, creating visual continuity on the shower floor, and to obtain greater drainage capacity. Both outlets: lower and lateral enable an easier installation.

The filter and built-in siphon can be removed for easy cleaning.

Grate: Wave-shaped punched.

Components

1. ABS drain/strainer (Acrylonitrile Butadiene Styrene).
2. AISI 304 stainless steel grate.
3. Extractable siphon made of ABS (Acrylonitrile Butadiene Styrene).
4. Adapter from Ø1.6" to Ø2" (DM40 to DM50) with O ring.
5. Hook for grate extraction.



Profile

MODEL: WAVE
SIZE: 700 x 68 x 97 mm / 28" x 2.68" x 3.82"

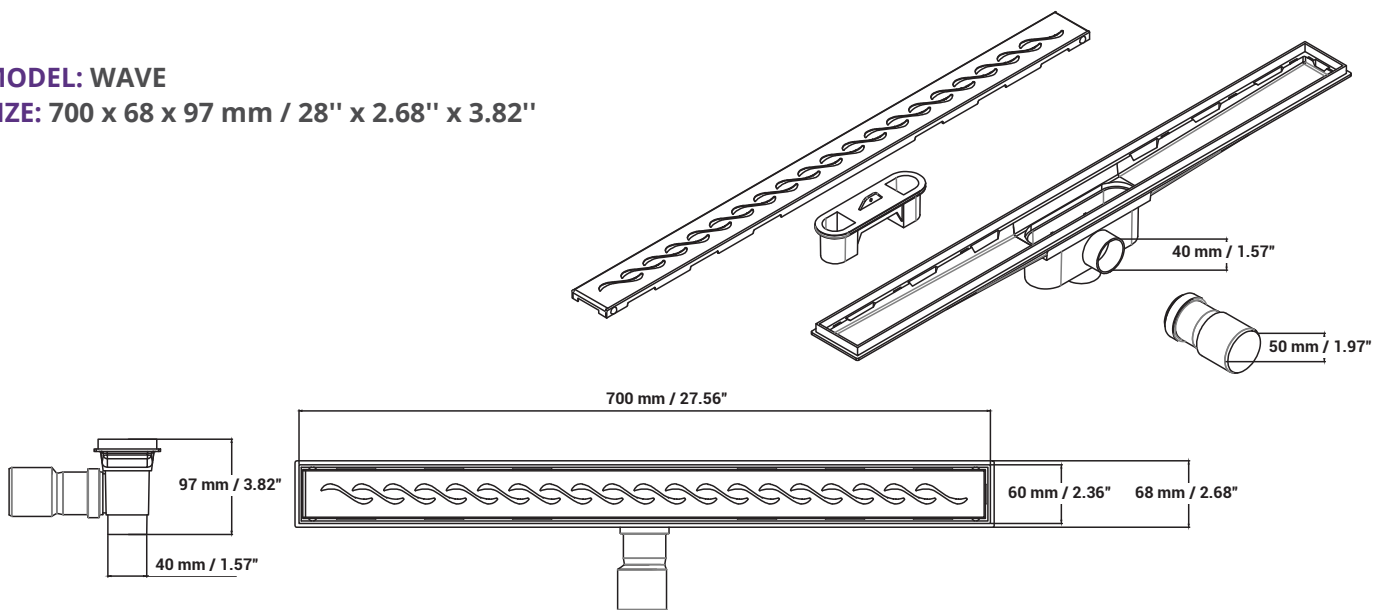

Uses and applications

It can be installed at the center of the shower, and it is suitable for all types of coatings. Designed for rooms that need water outlet, such as baths, showers, laundry rooms and balconies.

Advantages

- Drain/strainer flow of 25 L/min.
- Easy to install, it is placed alongside the leveling layer.
- Enduring grate, it does not rust.
- The ABS body provides greater structural resistance.
- Fast cleaning with access to the extractable siphon only by disassembling the grate.
- Suitable for wheelchairs.



Made of
304 stainless steel grate



ABS polymer body



Durability and resistance



5-year warranty



Easy to install



Anti-insects



Easy to clean

Installation method

ELEMENTS NEEDED:

- Spatula.
- Sealant/impermeable silicone.
- Grout.
- Leveling ruler.
- Microfiber cloth.

CONSIDERATIONS PRIOR TO THE INSTALLATION:

- The drain/strainer capacity is not determined by the siphon capacity but by the outlet pipeline to which it is connected. The drain pipelines must be at least Ø2".
- Make sure that there is an adequate slope in the outlet pipeline and the leveling layer. Said slope must be directed towards the drain, considering 1 cm per meter.

INSTALLATION:

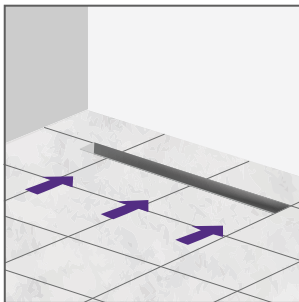

1. Determine the place where the linear drain/strainer will be installed. The position in the shower box can be at the back, front or center.

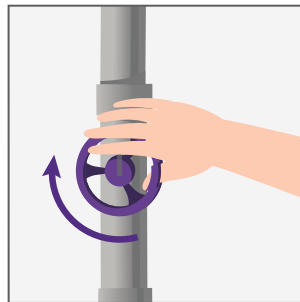

2. Close the outlet opening of the drain circuit before its mounting, to avoid the dirt produced during construction works from entering the duct

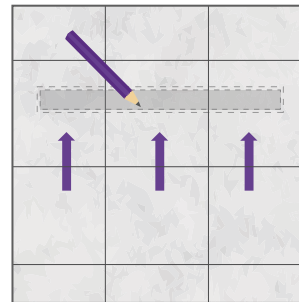

3. Place the drainage and mark the outline of the drain on the surface where you will perform the installation. The depth of the drainage is 3-3/8" (85 mm).

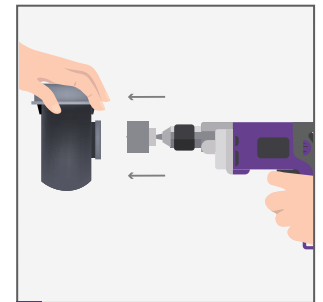

4. Make the hole in the corresponding outlet with a 1-3/8 or 1-7/16" (35 mm) hole saw.

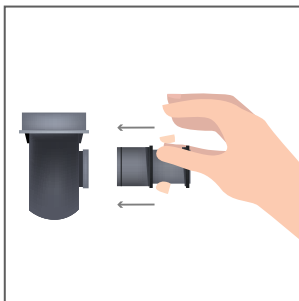

5. If necessary, connect the DM40/50 adapter to the outlet and insert it deeply to guarantee that the O-ring will retain any water seepage.

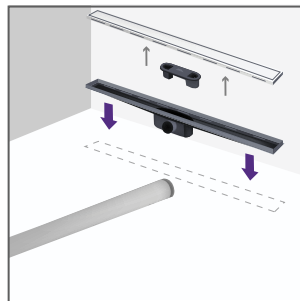

6. Connect the pipes of the drain network to the linear drain using glue on the connection.

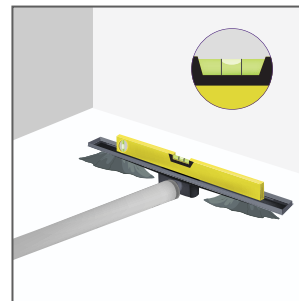

7. Pour the mortar mix into the bottom area of the drain base to provide support and guarantee the leveling.

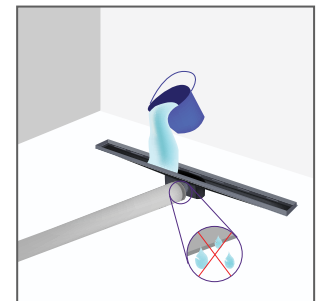

8. Perform a tightness test by pouring water into the drainage and check that the drain flows.

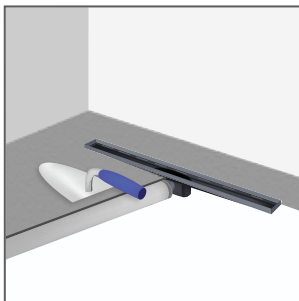

9. Spread the concrete mix up to the bottom edge of the drain base, generating a slope of at least 2% per linear meter towards the place where the drain will be installed. If you wish, install a waterproofing membrane following the manufacturer's instructions.

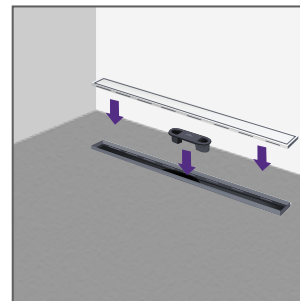

10. Place the inner siphon and the drain grate.

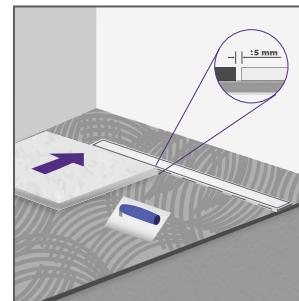

11. Install the ceramic tiles leaving +/- 1/4" (5 mm) of joint space with the edge of the drainage. To ensure the correct drain flow, the ceramic tiles must be placed 1 mm higher than the upper part of the drain. The installation can be performed with ceramic tiles of up to 3/8" high (9 mm). The sealing between the floor and the coating must be elastic and impermeable.

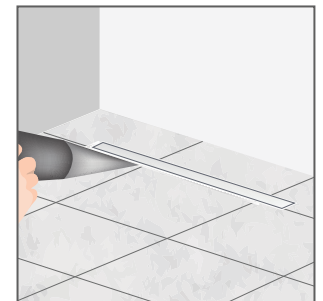

12. Apply silicone sealant to the drain edge, covering the joint properly, to guarantee proper fixation and waterproofing.

Cleaning and maintenance

To remove the dirt from the drain/strainer, use the hook to remove the grate, extract the basket strainer and clean with a sponge and home-use soap. Rinse with water.

Rub the grate with a cleaning concentrate for stainless steel surfaces making circular movements and rinse. To buff it, dry with a microfiber cloth.

Do not use abrasive cleaners, cleaning powder and/or metallic sponges that could damage the surface.